

Frequency Scanned Interferometer for LC Tracker Alignment



Hai-Jun Yang, Sven Nyberg, Keith Riles

University of Michigan, Ann Arbor

Victoria Linear Collider Workshop

British Columbia, Canada

July 28-31, 2004



LC - Silicon Detector



- Barrel – 5 layers, inner/outer radii – 20/125 cm, Silicon drift detector or microstrips

$$\sigma_{r\phi} = 10 \mu\text{m}, \sigma_{rZ} = 20 \mu\text{m}$$

Ref: SLAC-R-570 (2001)
hep-ex/0106058

- Forward – 5 disks, double-sided silicon microstrips

$$\sigma_{r\phi} = 7 \mu\text{m}, \sigma_{rZ} = 7 \mu\text{m}$$

- Coverage - $|\cos(\theta)|=0.99$

- Boundary between barrel and forward disks - $|\cos(\theta)|=0.80$

- Wafer size – 10cm x 10cm

- Wafer thickness – 150 μm

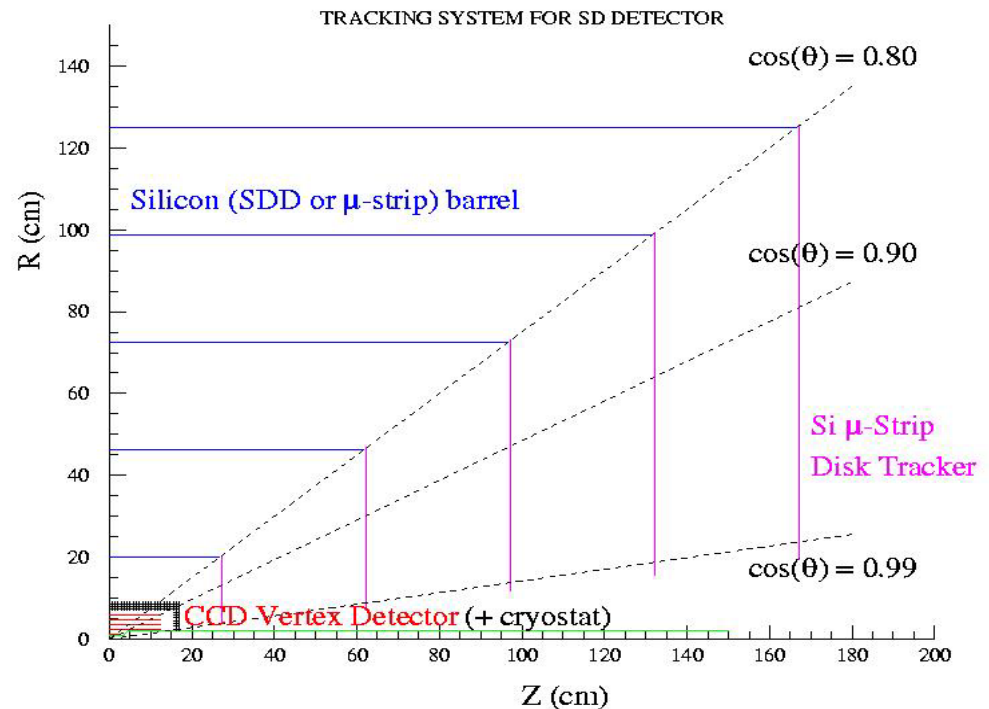



Physics Goals and Background



- ➔ To Carry out R&D toward a direct, quasi real time and remote way of measuring positions of critical tracker detector elements during operation.
- ➔ The 1-Dimension accuracy of absolute distance is on the order of 1 micron.
- Basic idea: To measure hundreds of absolute point-to-point distances of tracker elements in 3 dimensions by using an array of optical beams split from a central laser. Absolute distances are determined by scanning the laser frequency and counting interference fringes.
- Assumption: Thermal drifts in tracker detector on time scales too short to collect adequate data samples to make precise alignment.

Background – some optical alignment systems

- RASNIK system: used in L3, CHORUS and CDF,
will be used in ATLAS and CMS
- Frequency Scanned Interferometer(FSI): will be used in ATLAS SCT
[A.F. Fox-Murphy et al., NIM A383, 229(1996)]
- Focusing here on FSI system for LC tracker detector



Principle of Distance Measurement



- The measured distance can be expressed by

$$R = \frac{c\Delta N}{2\bar{n}_g\Delta\nu} + \text{constant end corrections}$$

*c - speed of light, ΔN – No. of fringes, $\Delta\nu$ - scanned frequency
 n_g – average refractive index of ambient atmosphere*

- Assuming the error of refractive index is small, the measured precision is given by:

$$(\sigma_R / R)^2 = (\sigma_{\Delta N} / \Delta N)^2 + (\sigma_{\Delta\nu} / \Delta\nu)^2$$

*Example: $R = 1.0$ m, $\Delta\nu = 6.6$ THz, $\Delta N \sim 2R\Delta\nu/c = 44000$
To obtain $\sigma_R \cong 1.0$ μm , Requirements: $\sigma_{\Delta N} \sim 0.02$, $\sigma_{\Delta\nu} \sim 3$ MHz*



FSI Demonstration System (I)

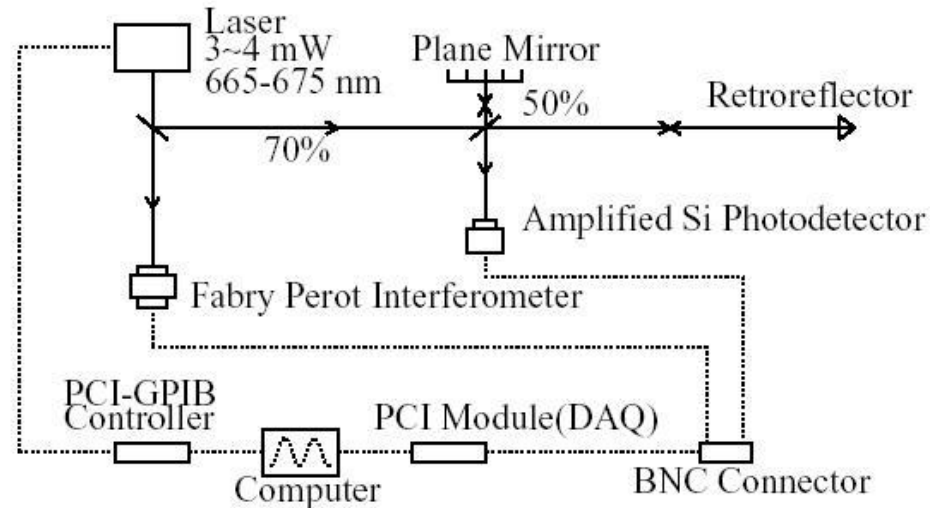

- ★ **Tunable Laser: New Focus Velocity 6308, 3-4 mW, 665.1-675.2 nm.**
- ★ **Retroreflector: Edmund, D=2", angle tolerance: ± 3 arc seconds.**
- ★ **Photodiode: Thorlabs PDA55, DC-10MHz, Amplified Si Detector, 5 Gain Settings.**
- ★ **Thorlabs Fabry-Perot Interferometer SA200, high finesse(>200) to determine the relative frequency precisely, Free Spectral Range (FSR) is 1.5 GHz, with peak FWHM of 7.5 MHz.**
- ★ **Thermistors and hygrometer are used to monitor temperature and humidity respectively.**
- ★ **PCI Card: NI-PCI-6110, 5 MS/s/ch, 12-bit simultaneous sampling DAQ.**
- ★ **PCI-GPIB Card: NI-488.2, served as remote controller of laser.**
- ★ **Computers: 1 for DAQ and laser control, 3 for analysis.**



FSI Demonstration System (I)

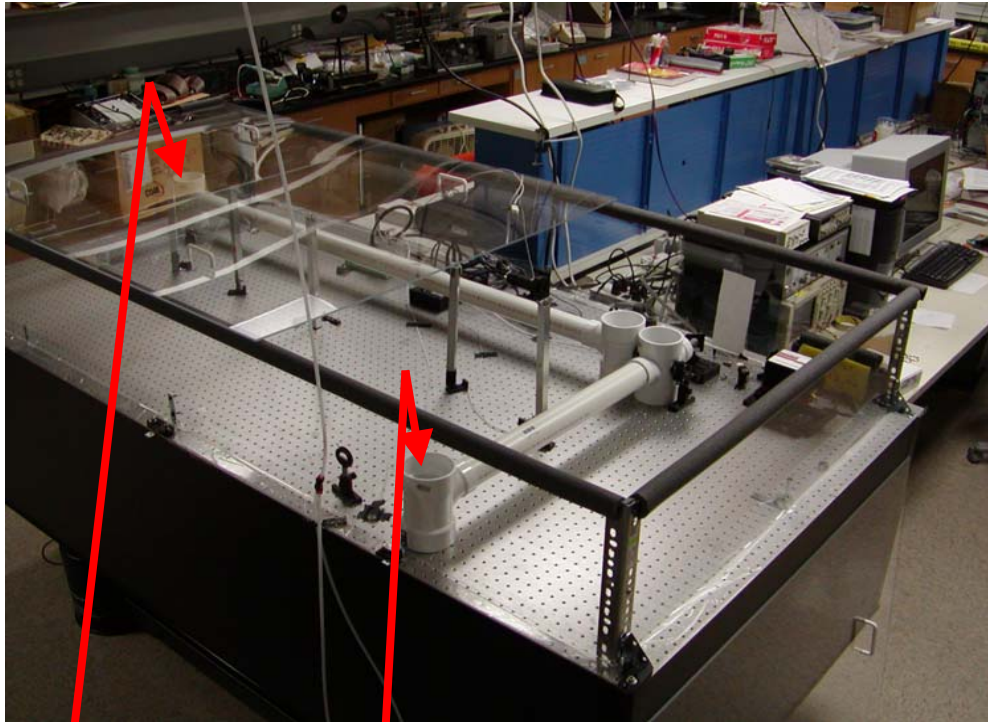

Fabry-Perot Interferometer

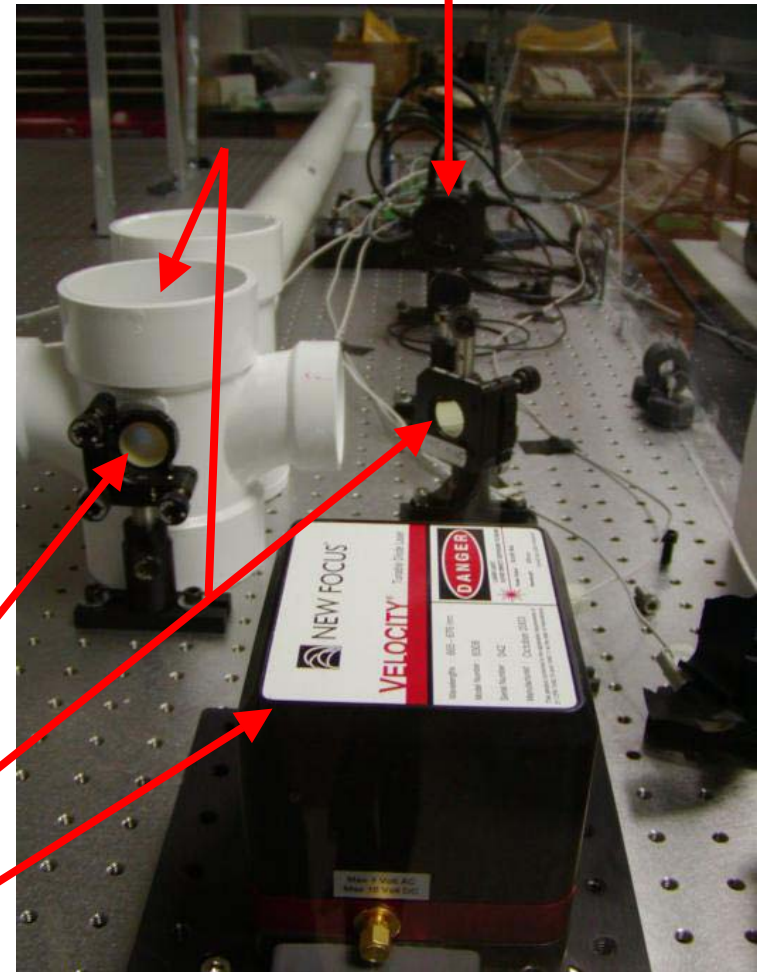

Photodetector

Retroreflector

Mirror

Beamsplitters

Laser



FSI with Optical Fibers (II)

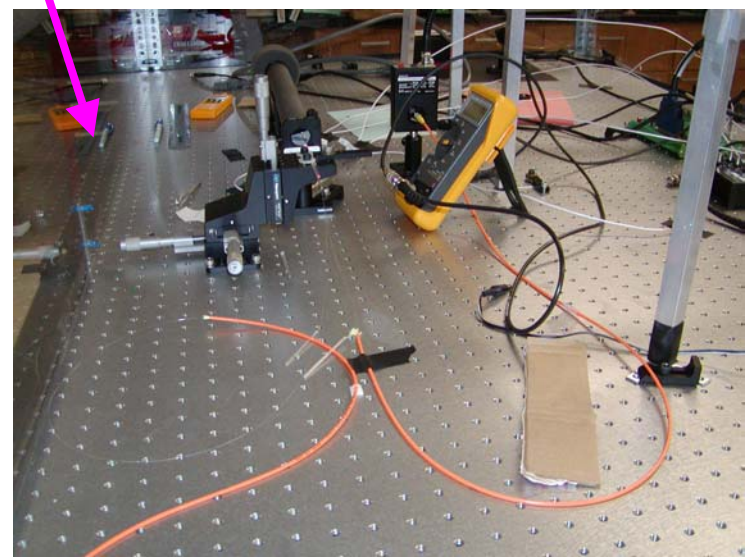
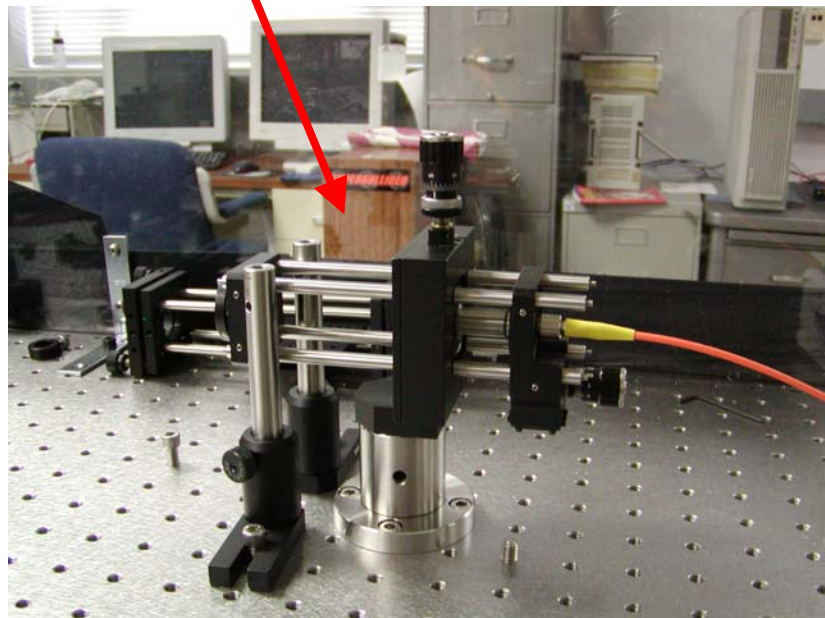
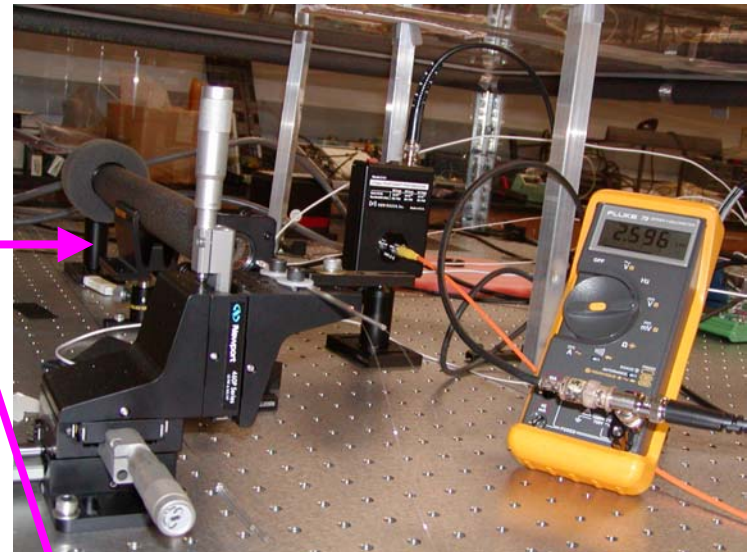
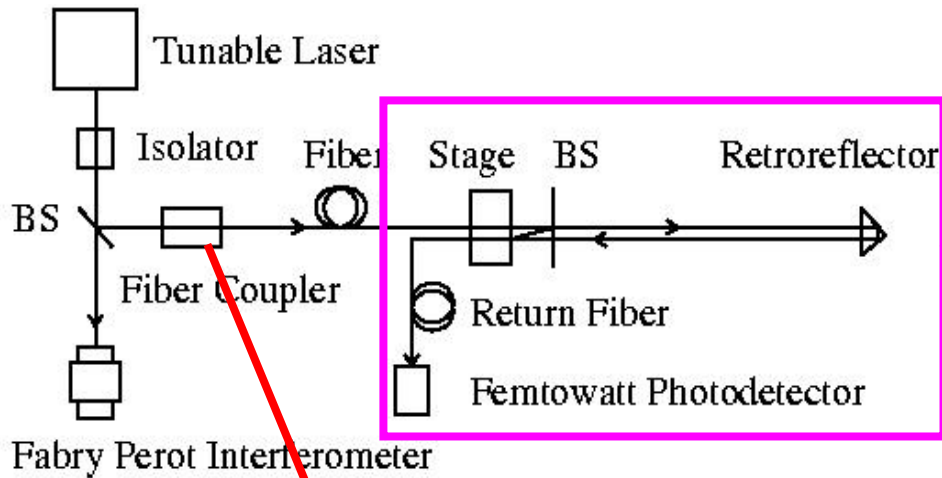



FSI with Optical Fibers (II)



- ◆ A key issue for the optical fiber FSI is that the intensity of the return beams received by the optical fiber is very weak.

e.g. the core of the single mode optical fiber has diameter of $5\ \mu\text{m}$.

Geometrical Efficiency: $\sim 6.25 \times 10^{-10}$ for a distance of $0.5\ \text{m}$

→ A novelty in our design is the use of a gradient index lens (GRIN lens – 0.25 pitch lens with $D=1\text{mm}$, $L=2.58\text{mm}$) to collimate the output beam from the optical fiber. The density of the outgoing beam is increased by a factor of ~ 1000 by using the GRIN lens. This makes it possible to split the laser beam into many beams to serve a set of interferometers simultaneously.

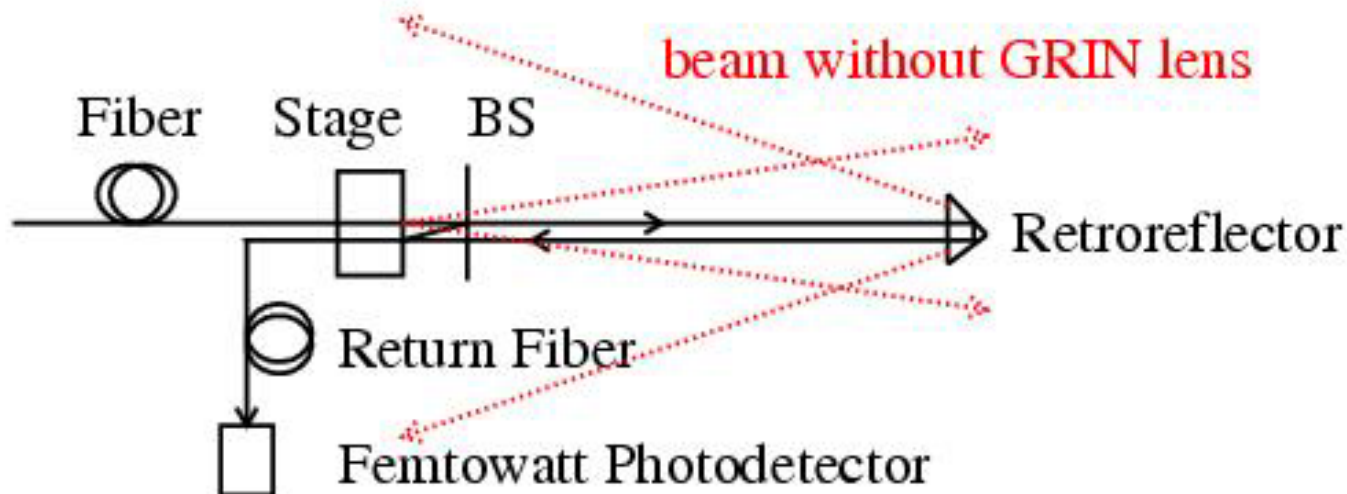



Multiple-Measurement Techniques



- If drift error(ε) occurs during the laser scanning, it will be magnified by a factor of Ω ($\Omega \equiv v/\Delta v \sim 67$ for full scan of our tunable laser),

$$\text{OPD}^{\text{measured}} = \text{OPD}^{\text{true}} + \Omega\varepsilon$$

➔ *Plastic box and PVC pipes are constructed to reduce thermal drift.*

- Assuming a vibration with one frequency:

$$x_{\text{vib}}(t) = a_{\text{vib}} \times \cos(2\pi f_{\text{vib}} t + \phi_{\text{vib}})$$

- Fringe phase at time t:

$$\Phi(t) = 2\pi \times [\text{OPD}^{\text{true}} + 2x_{\text{vib}}(t)]/\lambda(t)$$

$$\Delta N = [\Phi(t) - \Phi(t_0)]/2\pi = \text{OPD}^{\text{true}} \times \Delta v/c + [2x_{\text{vib}}(t)/\lambda(t) - 2x_{\text{vib}}(t_0)/\lambda(t_0)]$$

- If we assume $\lambda(t) \sim \lambda(t_0) = \lambda$, measured OPD can be written as,

$$\text{OPD}^{\text{meas}} = \text{OPD}^{\text{true}} + \Omega \times [2x_{\text{vib}}(t) - 2x_{\text{vib}}(t_0)] \quad (1)$$

$$\text{OPD}^{\text{meas}} = \text{OPD}^{\text{true}} - \Omega \times 4a_{\text{vib}} \sin[\pi f_{\text{vib}}(t-t_0)] \times \sin[\pi f_{\text{vib}}(t+t_0) + \phi_{\text{vib}}] \quad (2)$$

- ➔ Two new multiple-distance measurement techniques are presented to extract vibration and to improve the distance measurement precision based on Eq.1 and Eq.2, respectively.



Two Multiple-Measurement Techniques



→ Fix the measurement window size ($t-t_0$) and shift the window one F-P peak forward each time to make a set of distance measurements. The average value of all measurements is taken to be the final measured distance of the scan.

slip measurement window with fixed size

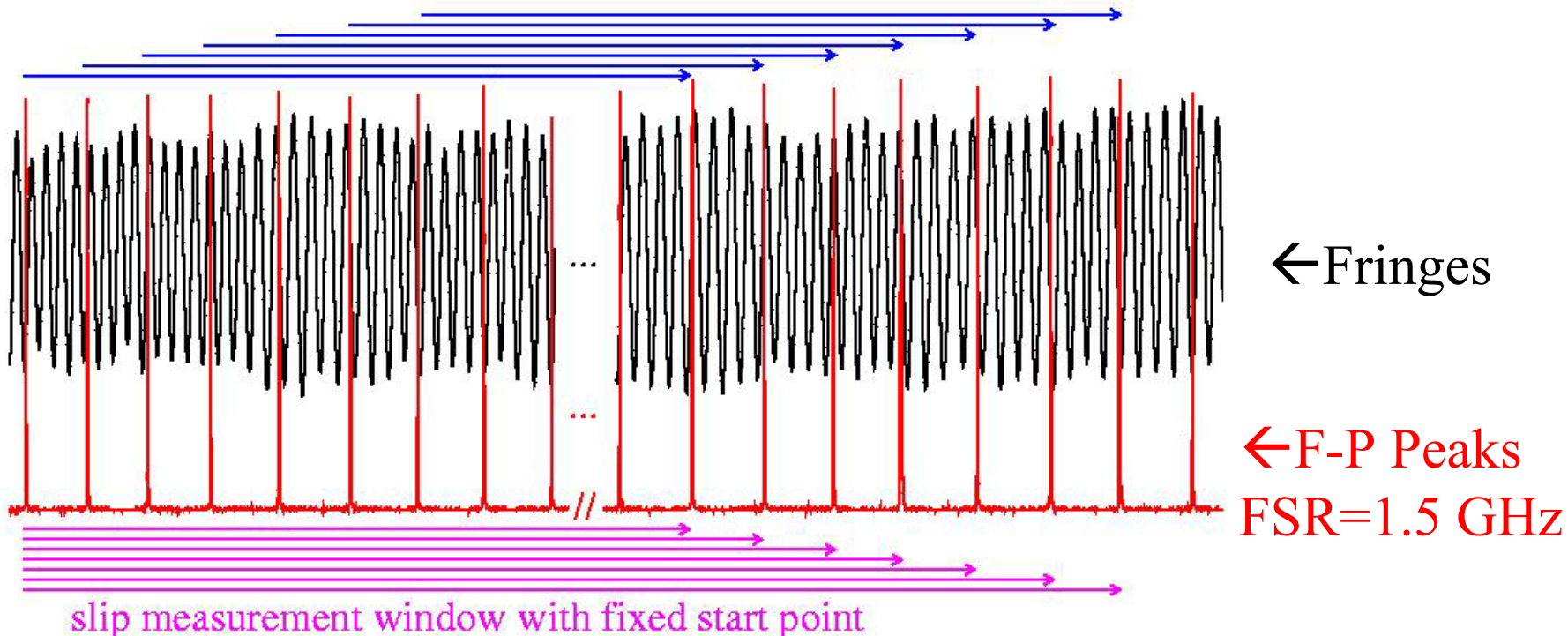

→ If t_0 is fixed, the measurement window size is enlarged one F-P peak for each shift. An oscillation of a set of measured OPD reflects the amplitude and frequency of vibration.



Vibration Test



- A PZT transducer was employed to produce controlled vibration of the retroreflector,

$$f_{\text{vib}} = 1.01 \pm 0.01 \text{ Hz}, a_{\text{vib}} = 0.14 \pm 0.02 \mu\text{m}$$

- Since the vibration is magnified for FSI during the scan, the expected reconstructed vibration amplitude is:

$$A_{\text{vib}} = 10.0 \pm 1.4 \mu\text{m}.$$

→ The extracted vibration

$$f_{\text{vib}} = 1.016 \pm 0.002 \text{ Hz},$$

$$A_{\text{vib}} = 9.82 \pm 0.06 \mu\text{m}$$

→ Measurable range

$$f_{\text{vib}} = 0.1 \sim 100 \text{ Hz},$$

$$a_{\text{vib}} = \text{few nm} \sim 1 \mu\text{m}$$

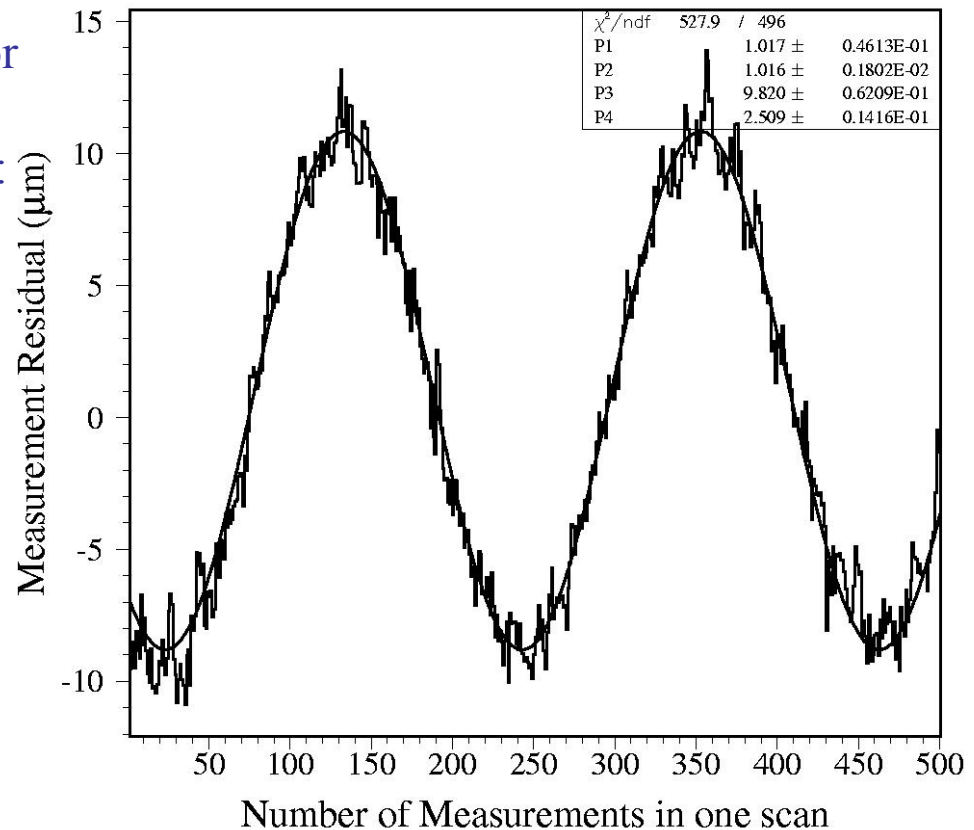



Absolute Distance Measurements



- The scanning rate was 0.5 nm/s and the sampling rate was 125 KS/s.
- The measurement residual versus the No. of measurements/scan shown in Fig.,
(a) for one typical scan,
(b) average values for 10 scans.

→ It can be seen that the distance errors decrease with increasing N_{meas} .

$N_{\text{meas}}=1$, precision=1.1 μm (RMS)

$N_{\text{meas}}=1200$, precision=41 nm (RMS)

→ Multiple-distance measurement technique is well suited for reducing vibration effects and uncertainties from fringe/frequency determination, BUT not good for drift errors such as thermal drift.

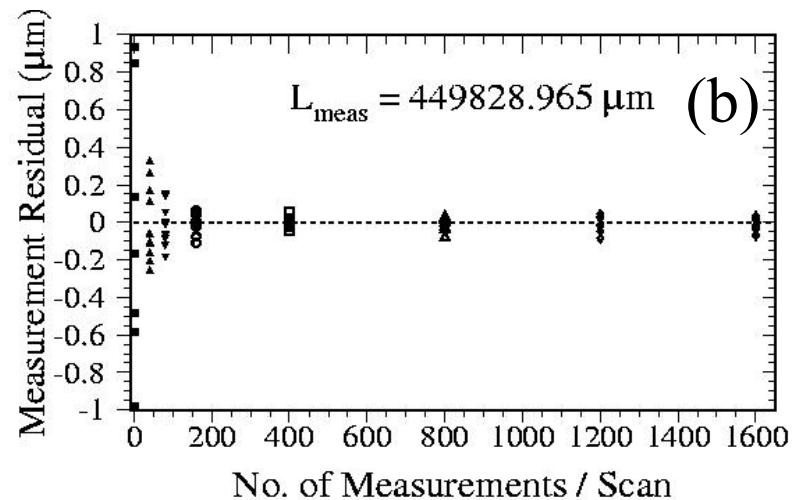
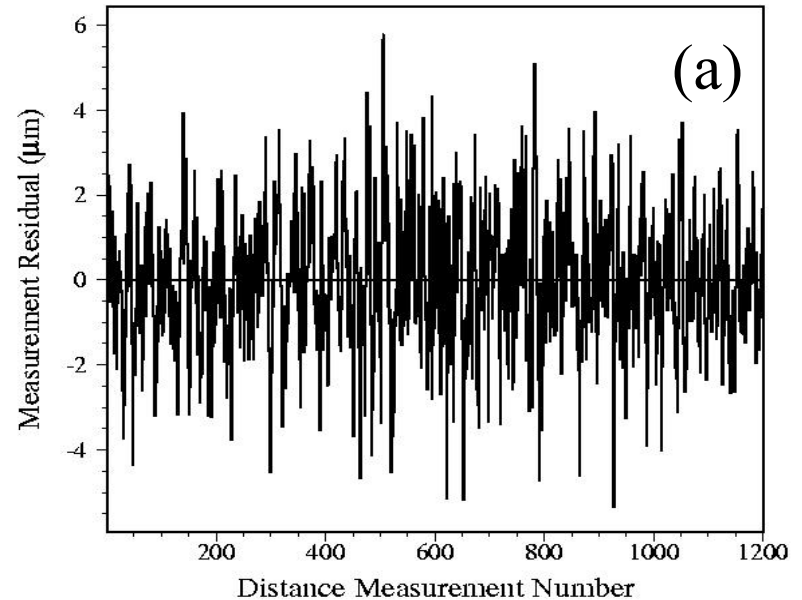

→ A dual-laser FSI intended to reduce the drift errors is under study currently. Two lasers are operating simultaneously, but the laser beams are isolated by using two choppers.

$$\begin{aligned} \text{Laser \#1: } D_1 &= D_{\text{true}} + \Omega_1 \varepsilon_1 \\ \text{Laser \#2: } D_2 &= D_{\text{true}} + \Omega_2 \varepsilon_2 \\ \text{Drift errors: } \varepsilon_1 &\approx \varepsilon_2 = \varepsilon \\ D_{\text{true}} &= (D_2 - \rho D_1) / (1 - \rho), \\ \text{Where } \rho &= \Omega_2 / \Omega_1 \end{aligned}$$

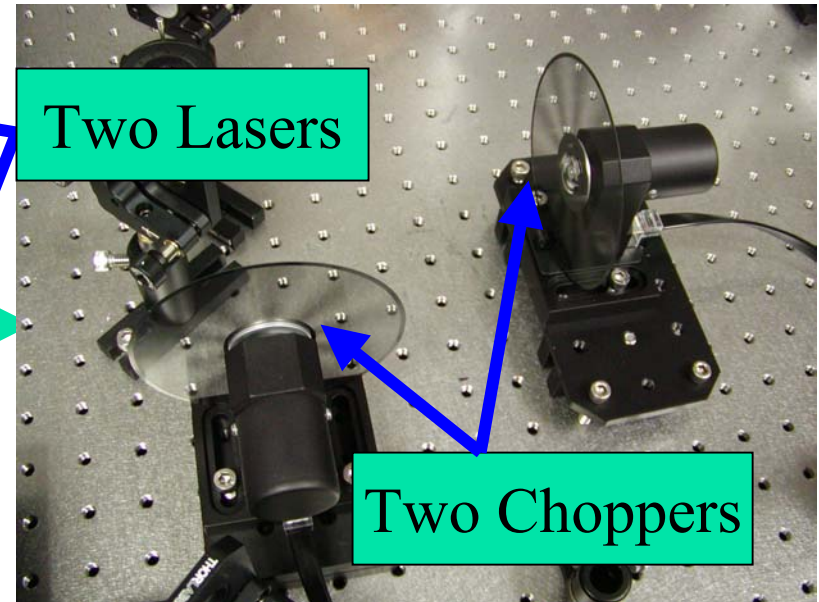
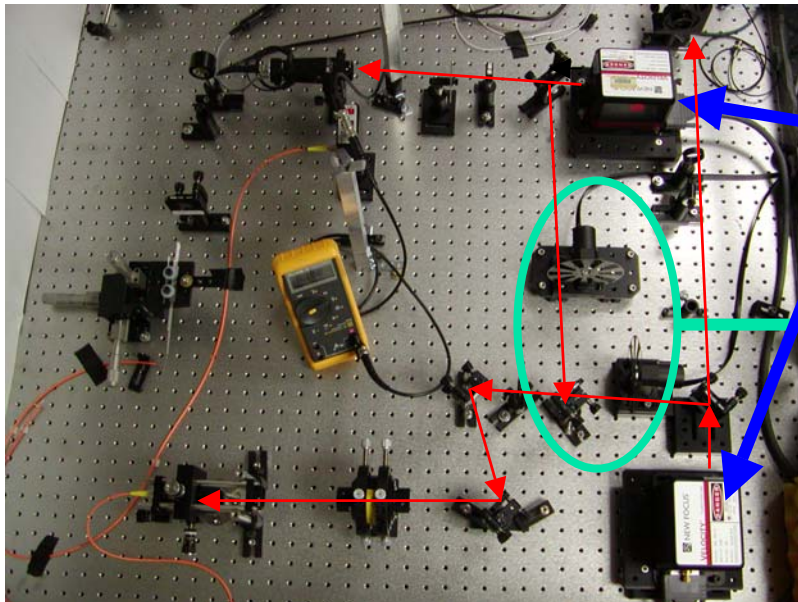



Comparison of FSI performances



- National Institute of Standards and Technology (NIST):
Air transport FSI, Distance: 30 cm – 5 m,
Precision: ~ 250 nm by averaging measurements of 80 independent scans.
[J.A. Stone et.al, Appl. Opt. V38. No. 28, 5981(1999)]

- University of Oxford – ATLAS Group
Optical fiber FSI, Distance: 20 cm – 1.2 m,
Precision: ~215 nm by using dual-laser technique to reduce drift errors
[P.A. Coe, Doctoral Thesis, U. of Oxford, 2001]

- University of Michigan – NLC Group
Optical fiber FSI, Distance: 10 cm – 0.6 m (measurable distance limited
by bandwidth of our femtowatt photodetector, 30-750 Hz)
Precision: ~50 nm by using new multiple-distance measurement technique
Vibration: 0.1-100 Hz, > few nanometers, can be extracted precisely
using new vibration extraction technique.
[Submitted to Applied Optics, 2004]



Summary and Outlook



- ➔ Two FSI demonstration systems, with or without optical fibers, were constructed to make high-precision absolute distance measurements.
- ➔ Two new multi-distance-measurement analysis techniques were presented to improve absolute distance measurement and to extract the amplitude and frequency of vibration.
- ➔ A high accuracy of ~ 50 nm for distances up to 60 cm under laboratory conditions was achieved.
- ➔ Major error sources were estimated, and the expected error was in good agreement with measured error from real data.
- ➔ We are investigating dual-laser scanning technique used by Oxford ATLAS group currently.
- ➔ Michigan group has expanded the frontier of FSI technology, but much work lies ahead.



BACKUP SLIDES



BACKUP SLIDES



Absolute Distance Measurements



Each precision listed is for standard deviation (RMS) of 10 scans.

Measured Distance(cm)	Precision for Open box(μm)	Precision for Closed box(nm)	Scan rate (nm/s)	FSI(Air or Optical Fiber)
70.64516 <i>(10-29-2003)</i>	3.5 ~ 5.0	47, 43, 51 30, 34	0.5	Air FSI
10.38511 <i>(06-14-2004)</i>	1.1, 1.0	19, 35	2.0 0.5	Optical Fiber FSI
20.55507 <i>(06-11-2004)</i>	N/A	36, 32 45, 28	0.8 0.4	Optical Fiber FSI
41.02587 <i>(06-15-2004)</i>	5.7, 4.4	56, 53	0.4	Optical Fiber FSI
61.40595 <i>(06-16-2004)</i>	N/A	51	0.25	Optical Fiber FSI



Temperature Measurements

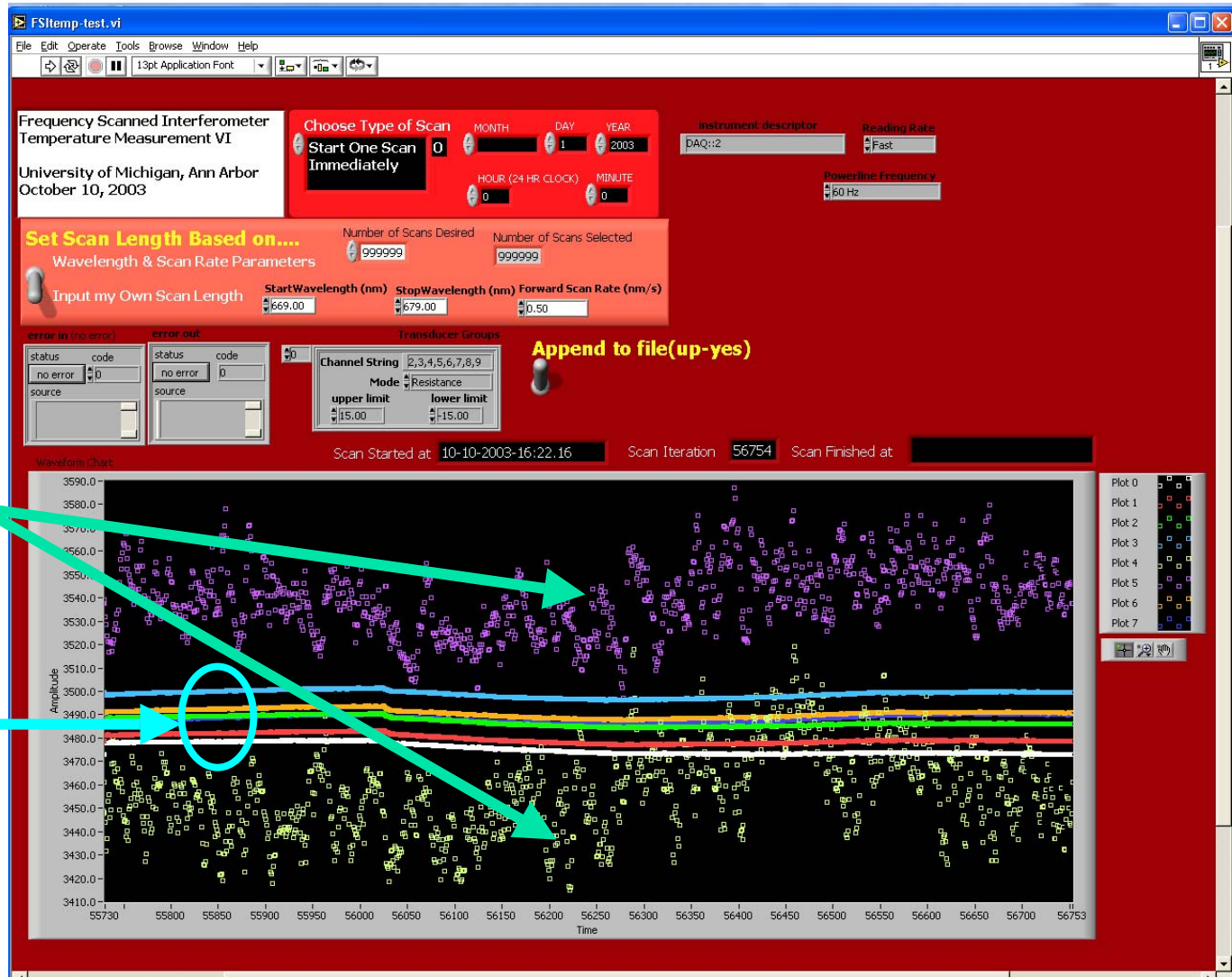

Outside of Box

Inside of Box



Error Estimations



- Error from uncertainties of fringe and frequency determination, $dR/R \sim 1.9$ ppm; if $N_{\text{meas}} = 1200$, $dR/R \sim 77$ ppb
- Error from vibration. $dR/R \sim 0.4$ ppm; if $N_{\text{meas}} = 1200$, $dR/R \sim 11$ ppb
- Error from thermal drift. Temperature fluctuations are well controlled down to 0.5 mK(RMS) in Lab by plastic box on optical table and PVC pipes shielding the volume of air near the laser beam. An air temperature change of 1 °C will result in a 0.9 ppm change of refractive index at room temperature. The drift will be magnified during scanning. if $N_{\text{meas}} = 1200$, $dR/R \sim 0.9$ ppm/K \times 0.5mK \times $\Omega(94) \sim 42$ ppb.
- Error from air humidity and pressure, $dR/R \sim 10$ ppb.

The total error from the above sources is ~ 89 ppb which agrees well with the measured residual spread of 90 ppb.



Systematic Error Estimations



The major systematic bias comes from uncertainty of the Free Spectral Range (FSR) of the Fabry Perot interferometer used to determine scanned frequency range precisely, the relative error would be $dR/R \sim 50$ ppb if the FSR was calibrated by an wavemeter with a precision of 50 ppb. A wavemeter of this precision was not available for the measurement described here.

Systematic bias from uncertainties of temperature, air humidity and barometric pressure scales should have negligible effect.

The total systematic error of above sources is ~ 50 ppb.

RASNIK provides alignment monitoring with submicron precision, developed at NIKHEF.

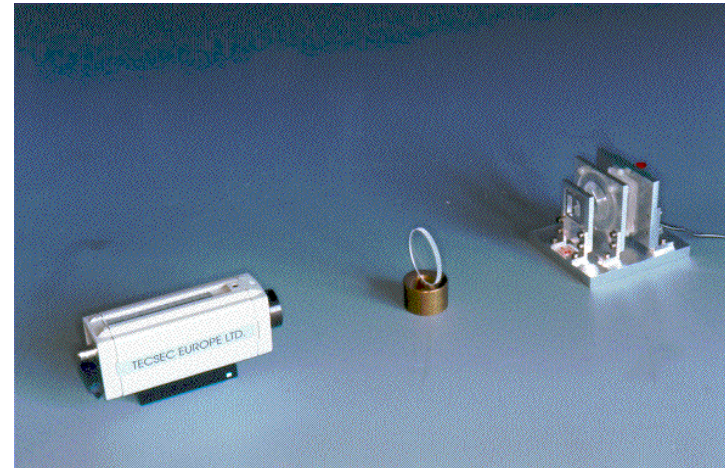
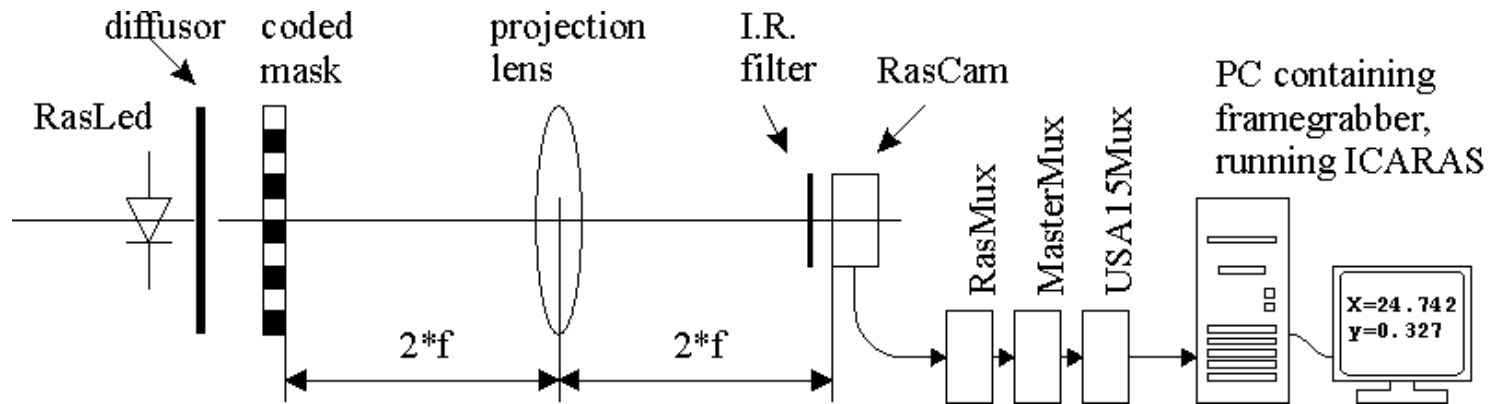



Fringe & F-P peaks for One Laser



- Fringe is intensity oscillation of two interference laser beams while scanning.

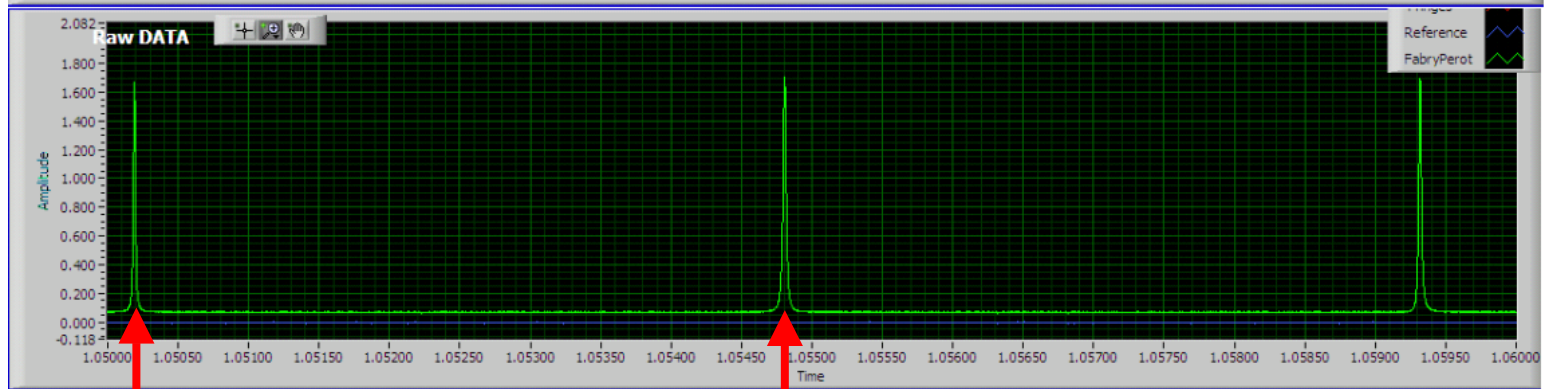
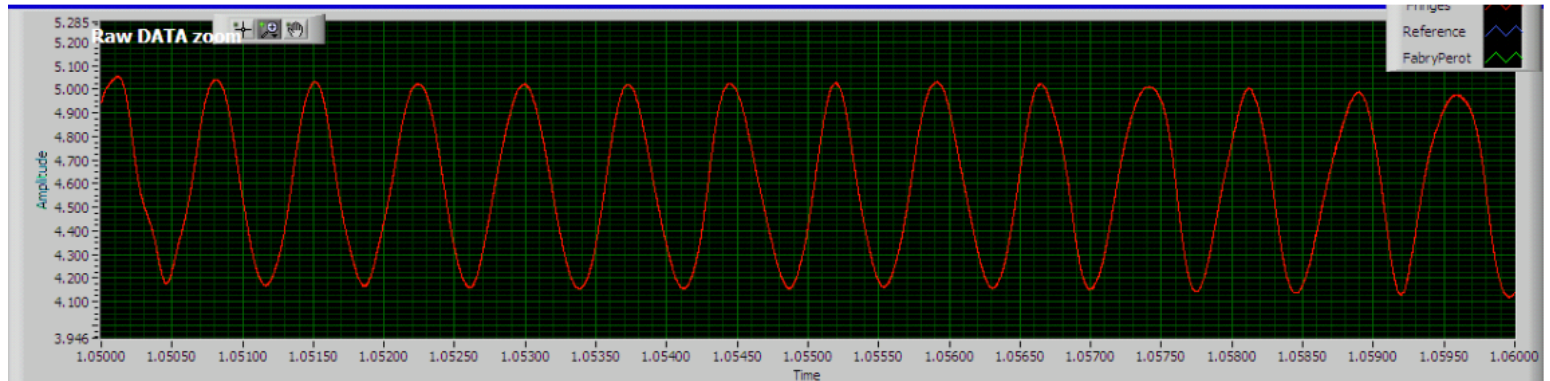

FSR = 1.5 GHz



Fringes & F-P Peaks for Dual-Laser

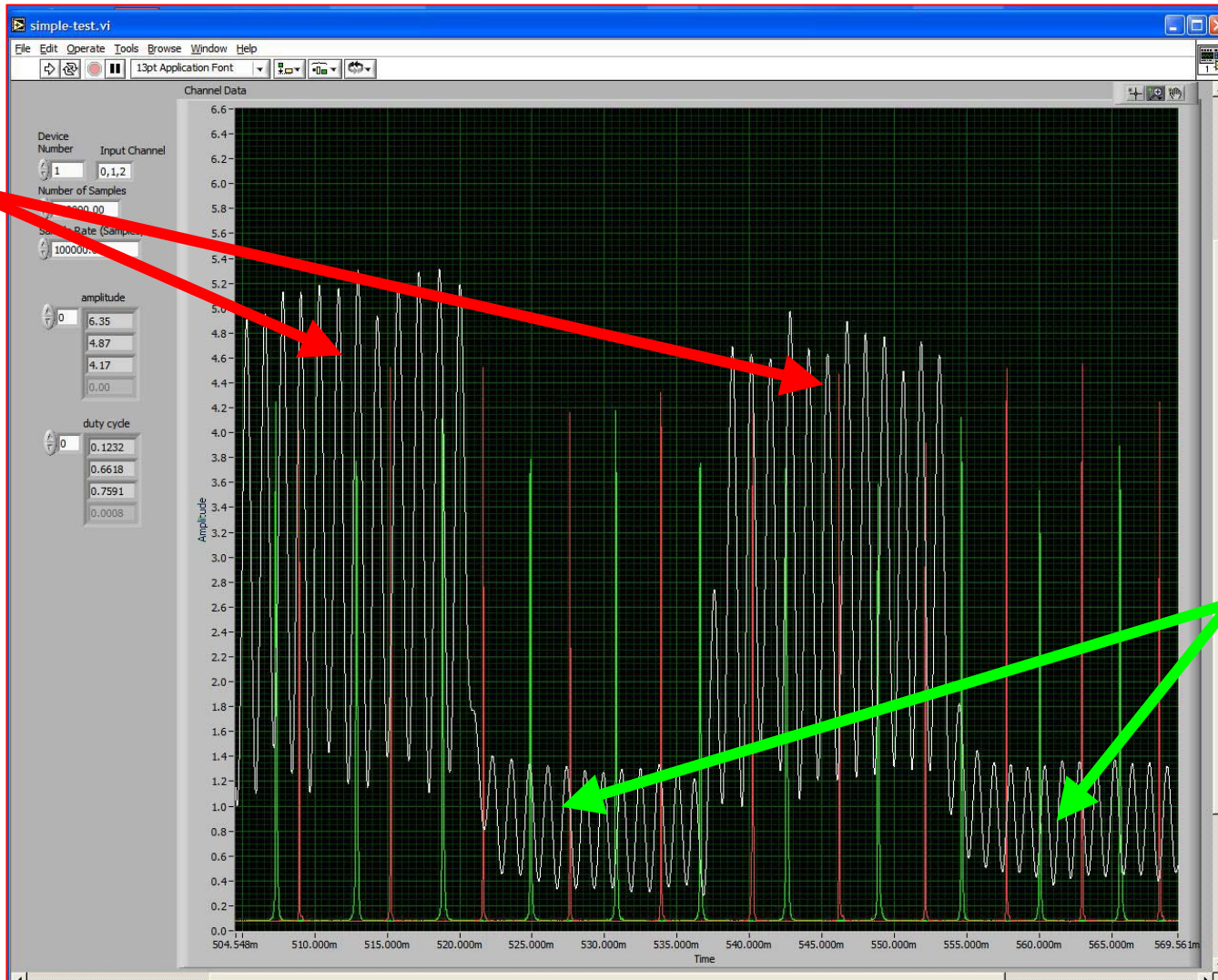

Laser-1

Laser-2

Components of FSI System

